





























230x280 A-CNC-R 27x0,9

	 0°	 45°	 60°	 45°	 60°	 $\begin{matrix} b \\ a \times b \end{matrix}$
 230	 180	 110	 x	 x	 x	 x
 280x200	 180x170	 100x70	 x	 x	 280x120	 280x120
 3x400V 50 Hz	 1,5	 20-100	 2720x27x0,9	 780		
L 2305	B 2260	Hmin 1405	Hmax 1780	V 800		



STANDARD OPTION

230-F

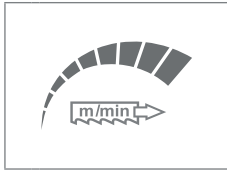

230-PUD

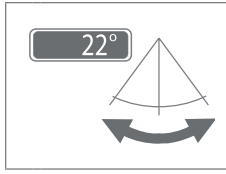

240-CK

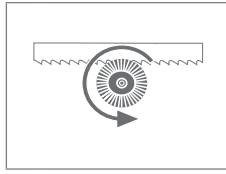

230-DPP

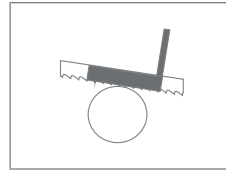

PEGAS-BRP

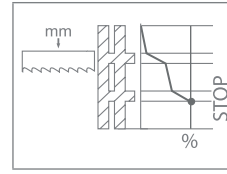

LASER LINE

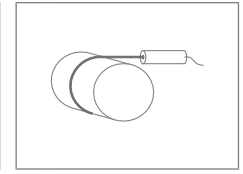

230-HP-A

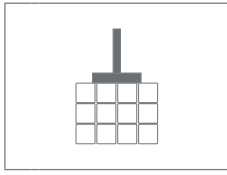

MINI LUBE 27-34

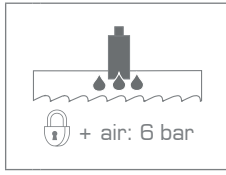

R 290

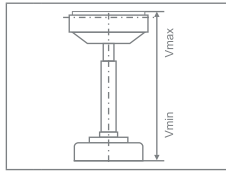

LIGHT L1

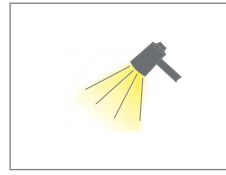

MITSUBISHI HMI 7"

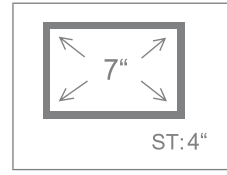

230-RTS-A

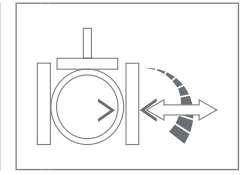

RB 200

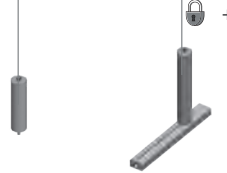

RBS 200/290
+RB

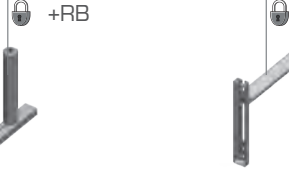

RHS 290
+RBS+RB

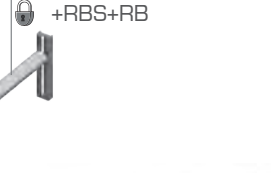

230-VTT

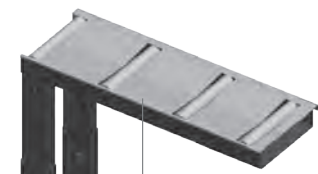

RD 1000/290



RD 2000/290



BOX-PCS

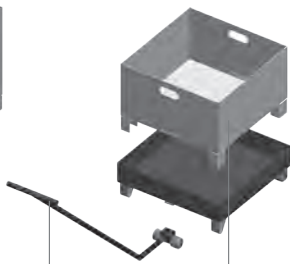

BOX-TAH

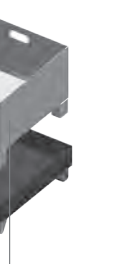

BOX-TRI



RD 1000/290

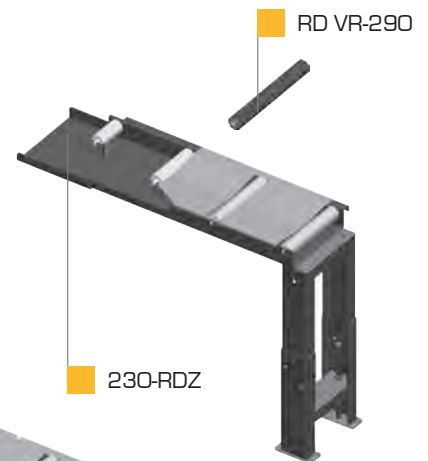

RD VR-290

230-RDZ



RDN



CONTROL PANEL: MITSUBISHI NC

230x280 A-CNC-R

- výrobce si vyhrazuje právo provádět změny technických údajů, technické údaje odpovídají 1.1.2023 / producer has the right to make changes of technical data, technical data are valid on 1.1.2023

- pila na fotografii není vždy v základním provedení, uvedené rozměry odpovídají stroji v základním provedení / the machine in the picture is not always in the basic version, mentioned diameters are for machine in basic version

* doporučená hodnota. Při překročení doporučeného maximálního průměru není možné garantovat výkon pilového pásu!

/ recommended value. The blade performance cannot be guaranteed when the recommended diameter is exceeded!

☒ - řezání svazků bez horního přitlačku / cutting of the bundle without top clamping



PEGAS - GONDA s.r.o.
Čs.armády 322, 684 01 Slavkov u Brna,
CZECH REPUBLIC

www.pegas-gonda.cz
00420-544 221 125 (126) | pegas@gonda.cz